

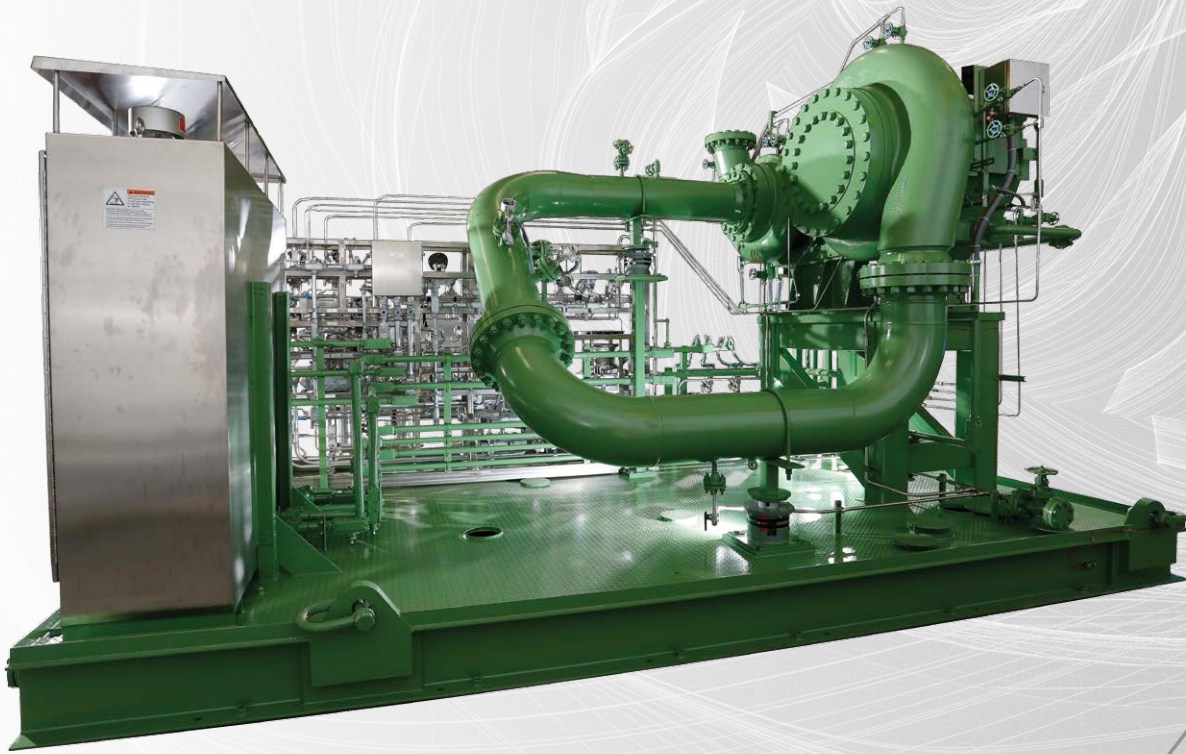

Process Gas Centrifugal Compressors

Efficient, Reliable Equipment



The Advantages of Centrifugal Compressor Technology

Integrally geared centrifugal compressors represent the latest technology, offering significant advantages over outdated, less-efficient and more costly compressor designs. These advantages are inherent in the centrifugal design and are further enhanced by Ingersoll Rand's more than 60 years of centrifugal expertise.









The compressor package pictured on the cover is a debutanizer compressor in an NGL fractionation process. Read more about compressor applications in NGL on page 9.



Compare the innovative technology of MSG® and MSG® TURBO-AIR® centrifugal compressors with other machines, such as positive displacement compressors, and the advantages are clear.

**MSG® AND MSG® TURBO-AIR®
CENTRIFUGAL COMPRESSORS**

OTHER COMPRESSORS

<p>LOW MAINTENANCE</p> 	<ul style="list-style-type: none"> • Compression elements do not wear or require periodic replacement • Oil filter elements and seal gas filter elements are easily replaced online • Bearings designed for extended life 	<ul style="list-style-type: none"> • Require regular maintenance, such as replacement of piston rings, gland packing and valve plates, or periodic replacement of air ends • Result in high operating expenses and significant machine downtime
<p>OIL-FREE PROCESS GAS</p> 	<ul style="list-style-type: none"> • 100% oil-free per ISO 8573-1 certification • Prevent contamination of system • Meet strict downstream requirements 	<ul style="list-style-type: none"> • Oil filters must be installed at discharge • Potential for oil carryover to foul the process • Oil free claim is based dependent on uninterrupted seal gas supply
<p>HIGH RELIABILITY</p> 	<ul style="list-style-type: none"> • Centrifugal compressors are proven to have a long mean time between failures (MTBF), and independent research has shown an industry-leading availability of 99.7% • Conservative, high-quality gear design 	<ul style="list-style-type: none"> • Contacting compression elements are subject to wear • Limited rotating element life • Designed-in wearing items to generate aftermarket revenues
<p>NO PULSATION</p> 	<ul style="list-style-type: none"> • Pulsation-free and require no dampers 	<ul style="list-style-type: none"> • Require the use of large pulsation dampers to reduce pressure fluctuations
<p>OPTIMUM CONTROL</p> 	<ul style="list-style-type: none"> • Feature inlet guide vane control plus bypass for consistent gas delivery • Automatic operation and precision control for most operating conditions • State-of-the-art MAESTRO™-suite of controls • PLC control systems available 	<ul style="list-style-type: none"> • The use of cylinder unloading for stepped flow control can result in complicated process control due to sudden changes in capacity
<p>COMPACT INSTALLATION FOOTPRINT</p> 	<ul style="list-style-type: none"> • Capable of handling substantially higher volumes of gas in one or two small casings for a smaller overall package 	<ul style="list-style-type: none"> • May have four or six cylinders requiring more space for installation
<p>NO VIBRATION</p> 	<ul style="list-style-type: none"> • Essentially vibration-free • Require only a pad suitable for supporting the static weight of the package 	<ul style="list-style-type: none"> • Require large and deep foundation to handle heavy weight and unbalanced forces • Precautions must be taken to prevent transmission of vibration to other equipment

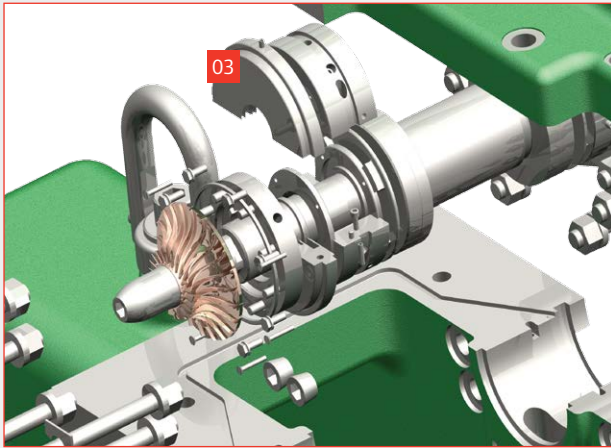

Engineered Air Applications

- Industrial gases
- High-pressure nitrogen
- Process air
- Instrument and utility air
- Decoking air
- American Petroleum Institute (API) standards
- Soot blowers
- Power generation

Gas Compressor Applications

- Fuel gas boosting
- Natural gas gathering
- Hydrocarbon refrigeration gas
- Carbon monoxide
- CO₂ (wet or dry)
- SynGas
- Low molecular weight recycle gas
- Landfill gas

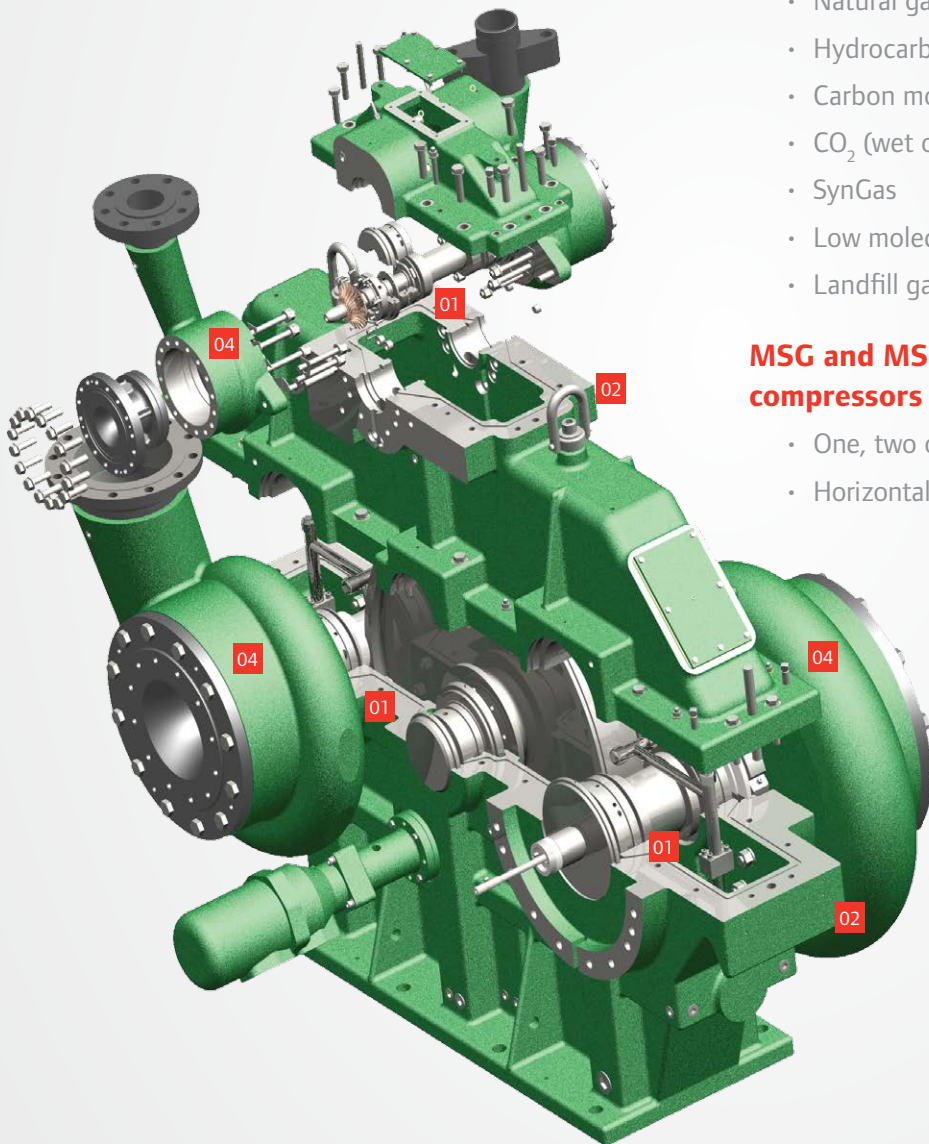

MSG and MSG TURBO-AIR centrifugal compressors are exceptional by design.

- One, two or three rotors, up to six stages per gearbox
- Horizontal splitline(s) for easy access to parts

Cross-sectional View of a Typical Three-rotor Process Gas Compressor

- 01: One, two or three rotors, up to six stages per gearbox
- 02: Horizontal splitline(s) for easy access to parts
- 03: Engineered seal designs
- 04: NACE-compliant scrolls and inlets can be manufactured from steel or stainless steel

Horizontally Split Gearbox for Easy Maintenance

- Allows inspection or replacement of gears, bearings and oil seals by simply lifting a cover
- No disassembly of piping or heat exchangers is necessary
- Periodic inspections and maintenance are made easy
- Reduced maintenance, increased uptime

Bullgears for Optimum Speed and Efficiency

- Allows each pinion to operate at optimum speed, as determined by the flow and efficiency characteristics of the impeller
- Main driver is connected directly to the compressor by a low-speed coupling
- Gears are high-speed, precision helical-type, designed to meet or exceed AGMA and ISO quality standards



Five-pad Tilting Pad Bearing Assembly

Tilting Pad Pinion Bearings for High Reliability

- Five-pad Tilting Pad bearings provide high stability and low vibration levels for high-speed shafts, which are subjected to variable loading over a wide range
- High reliability over the entire operating range, from full load to no load
- Pressure-lubricated and steel-backed for increased reliability

Rotor Assembly for Smooth Operation

- Each rotor assembly consists of a pinion shaft, to which one or two impellers are attached
- Pinion gears are hardened and precision-ground (AGMA and ISO quality) for longer life
- Smooth, vibration-free operation is assured through precision balancing

Tapered Rider Ring Thrust Collars on the Pinion Shaft

- Centrifugal design mitigates the majority of power-robbing thrust loads
- Thrust collars on pinion shaft create an oil wedge, which carries the small remaining net thrust to the bullgear where it is absorbed by a simple low-speed thrust bearing
- Reduces gearbox power losses while increasing mechanical integrity



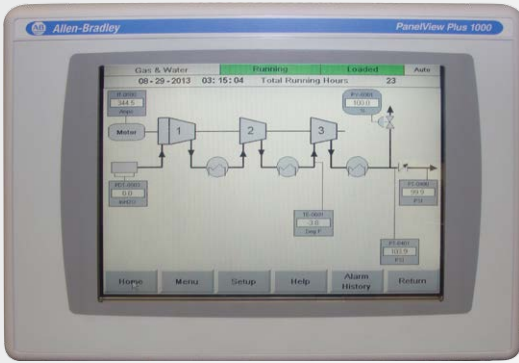

Allen Bradley PLC-based control center with PanelView Plus 1000 interface

Customized MAESTRO PLC-based Controls

Customer-defined PLC Controls

PLC-based systems are used for packages with high input/output (I/O) counts, multiple gas circuit control loops and multiple processes. PLCs by all major industrial suppliers are available. Ingersoll Rand can design, program and supply your specified PLC system mounted and wired to any compressor package.

- PLC system is fully tested by our Control Systems Engineering department before shipping
- Logic diagrams and programming software are standard
- Control systems can be locally mounted on the skid, designed with local I/O and remote processors, or any buyer-defined arrangement
- Control system enclosures and wiring are available for US and IEC applications, Class 2 / Zone 2 and non-hazardous installations
- Fully redundant PLC solutions are also available

Gas Flow Arrangement

MSG and MSG TURBO-AIR centrifugal compressors feature an advanced arrangement of gas flow components. Advantages of this arrangement include:

- Directed gas movement to reduce turbulence-induced friction
- Gas is cooled after every stage to provide high isothermal efficiency

Gas Flow Diagram

- 01: Compressor inlet
- 02: First-stage compressor volute
- 03: Coolant in
- 04: Coolant out
- 05: First-stage intercooler
- 06: Second-stage compressor volute
- 07: Second-stage intercooler
- 08: Third-stage compressor volute
- 09: Compressor discharge

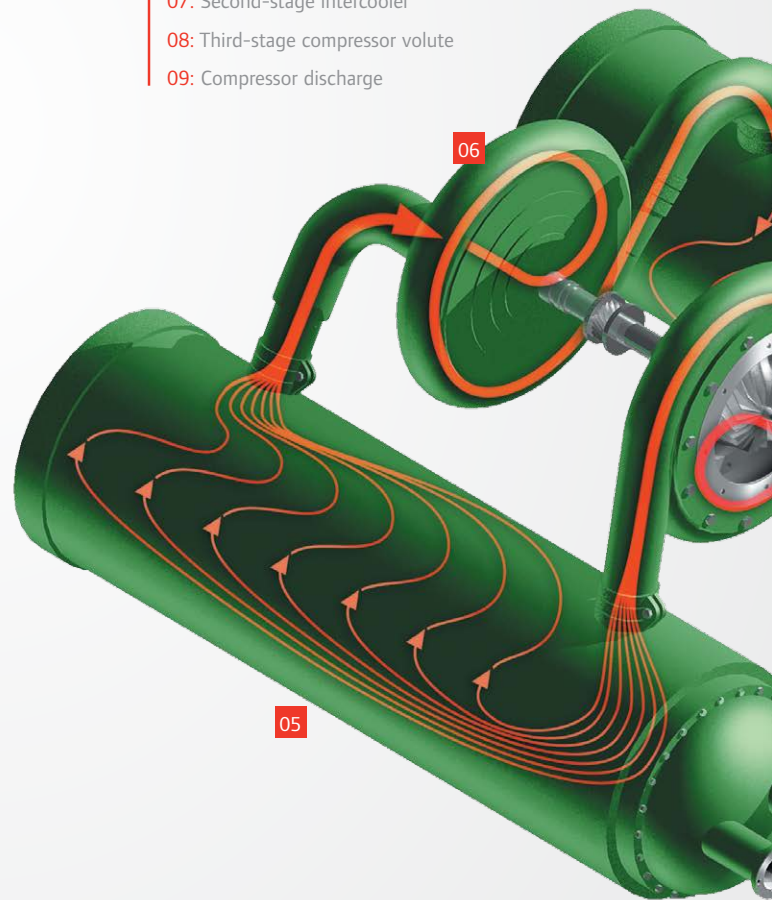

Packaging Concept

Ingersoll Rand's cutting-edge packaging concept gives you great flexibility to tailor a centrifugal compressor to meet your needs while simplifying installation and maintenance. Our MSG and MSG TURBO-AIR packages can include:

- Lubrication system
- Main driver
- Shaft coupling with guard
- Intercoolers
- Interstage piping
- Control panel

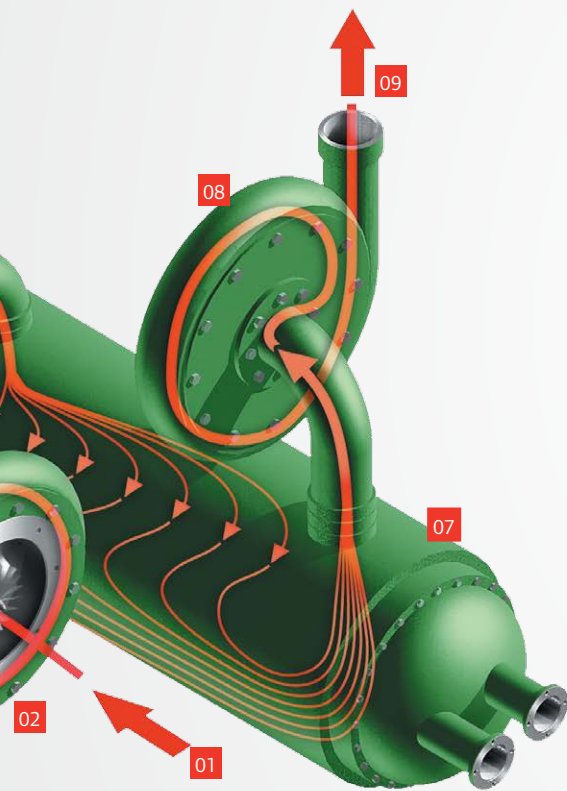

We can build standard compressor packages or specialized API 672/API 617 packages, all on a common baseplate for ease of installation.

Advanced Lubrication System

Ingersoll Rand's standard self-contained, low-pressure lubrication system:

- Includes an oil reservoir, mechanical oil pump, electric full-flow auxiliary oil pump, fixed-bundle oil cooler, single full-flow oil filter, safety devices and instrumentation for safe compressor operation
- Assembled and packaged on a compressor base when compressor layout permits
- Sized to serve the main driver
- Can be designed to meet:
 - Custom specifications
 - API 672 (packaged centrifugal)
 - API 617 (centrifugal process gas compressor)
 - API 614 (lubrication system)
 - Process Industry Procedures (PIP)
- Interconnecting piping between the lubrication system and compressor when compressor, intercooler(s) and main oil pump arrangement permits

Intercoolers Guarantee Increased Heat Transfer

Our ASME-coded intercoolers (PED, China Code Pressure Vessel Certification, GOST, KOSHA, and others, as required) provide efficient cooling between stages and are designed to be accessible for inspection and cleaning.

- Water-in-tube cooler designs allow for easy cleaning in areas with poor water conditions
- Extended-surface, plate-fin design provides increased heat transfer with reduced space requirements
- Accessible, smooth-bore tubes are easily rodded with bundles in place
- No disassembly of any other part of the compressor is necessary to perform maintenance
- Gas-in-tube style TEMA C and TEMA R designs are available options

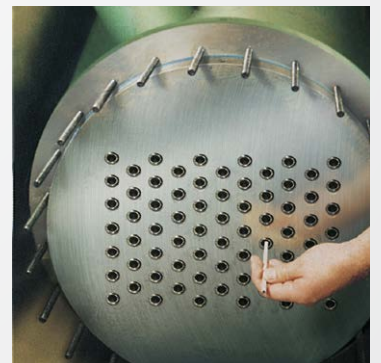

Process Gas Seal Support

Gas seal support systems are designed, built and tested per API 614. System designs can be based on differential pressure control, flow control or other control methods. The scope of supply is virtually unlimited and fully automatic. Manual or customer-specified systems can be engineered for most gas seal types.

Systems are designed with instrumentation to monitor seal condition. Filters and accessories are supplied with sufficient instruments to plan maintenance and reduce downtime. The goal is to save you time and money by providing worry-free operation of your equipment with simple maintenance.

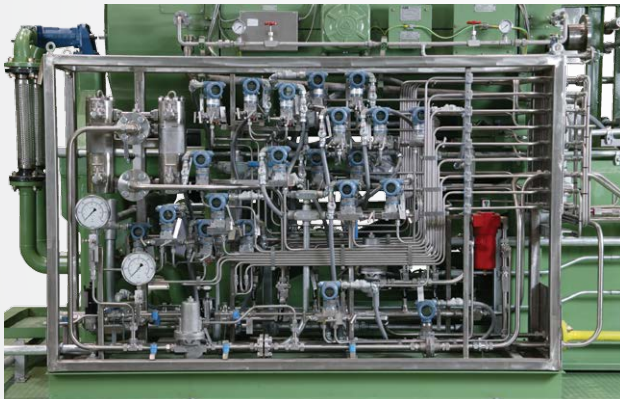

Gas seal instrumentation rack with 2-of-3 voting, seal and purge gas filtering

Aerodynamic Performance

Unique Impeller Designs

Impellers, diffusers and scrolls are uniquely designed to meet your specific needs. Examples of our impellers include:

Custom Engineered/Five-axis Milled

- Custom-designed using computational fluid dynamics (CFD) for aerodynamic design and finite element analysis (FEA) for mechanical integrity
- Optimized designs for custom applications
- Overall savings can be as great as a 5% increase in efficiency over some cast impeller designs



Fuel gas booster skid with scrubber, bypass piping

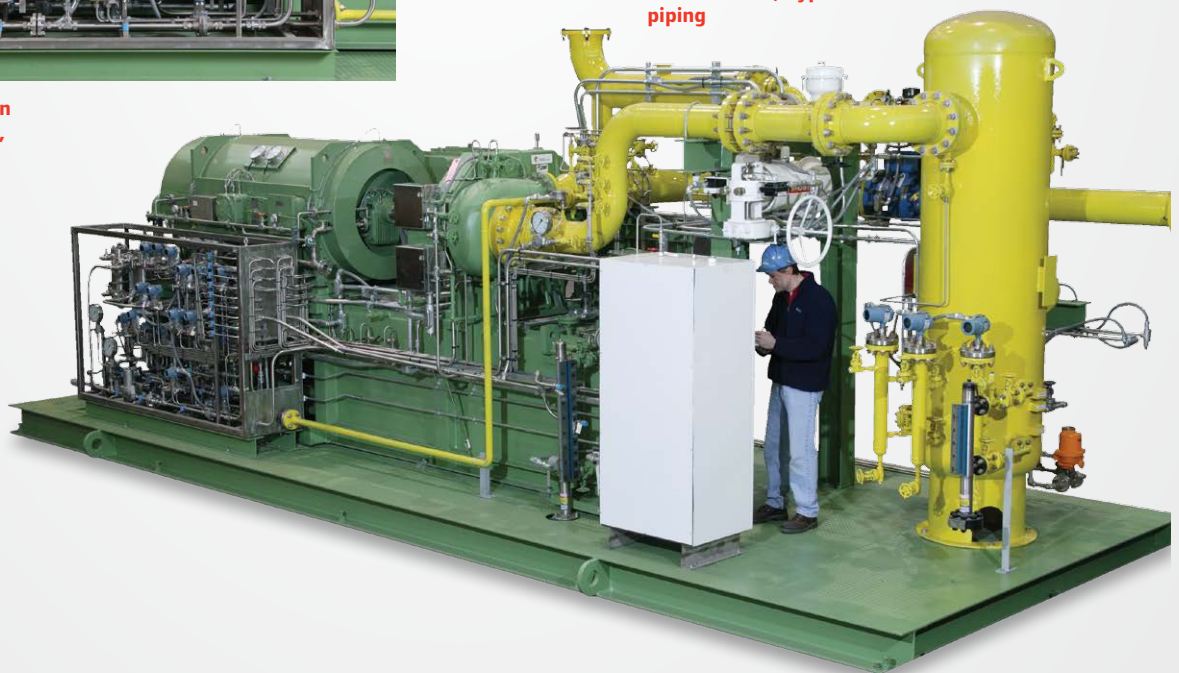

Gas Seal Options for Your Process Applications

Multiple gas seal designs are available for a wide range of process gases and leakage requirements. Ingersoll Rand can suggest a seal type based on your process, or we can design the seal of your choice – all major seal suppliers can be used.

Ingersoll Rand’s standard dry-face seal uses a floating self-centering rider. The clearance fit allows the seal to be removed easily and installed without puller tools. The seal comes as a complete assembly with an installation plate.

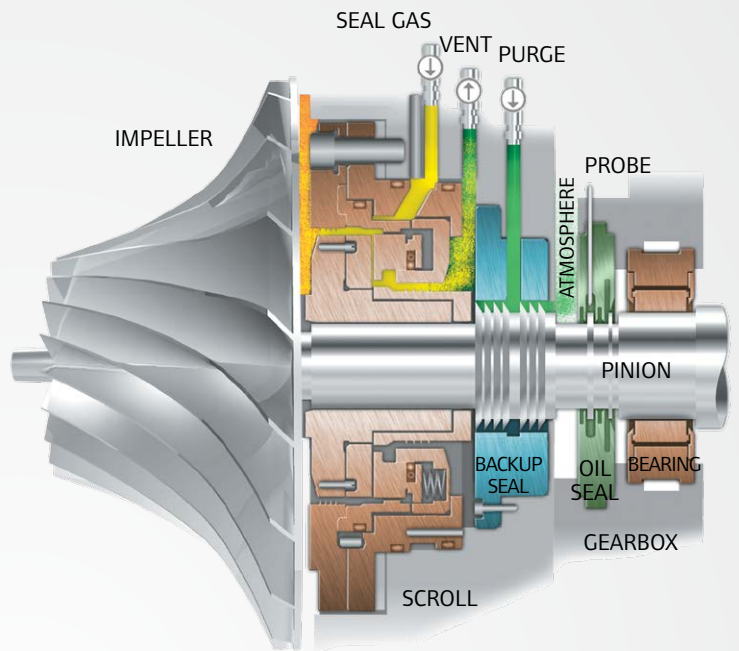

Single dry-face seal with a babbitted labyrinth backup

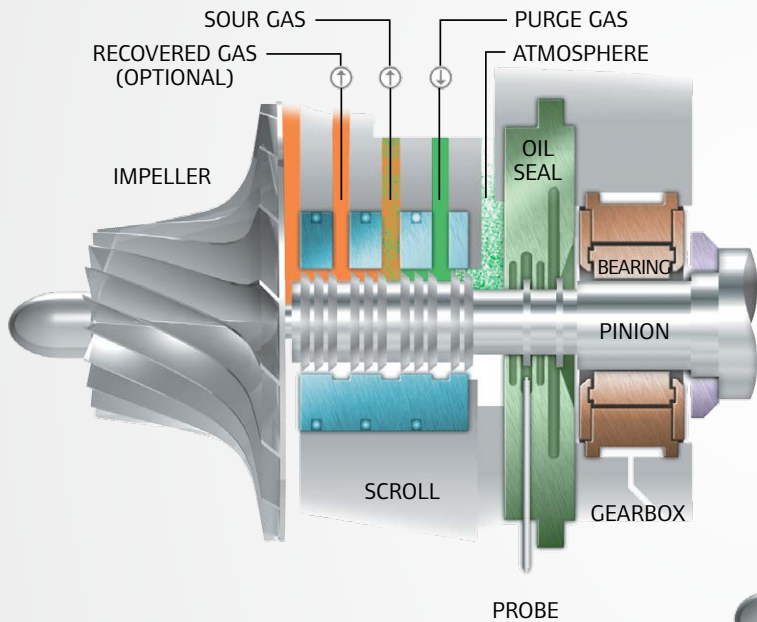

Multiport babbitted labyrinth seal with purge

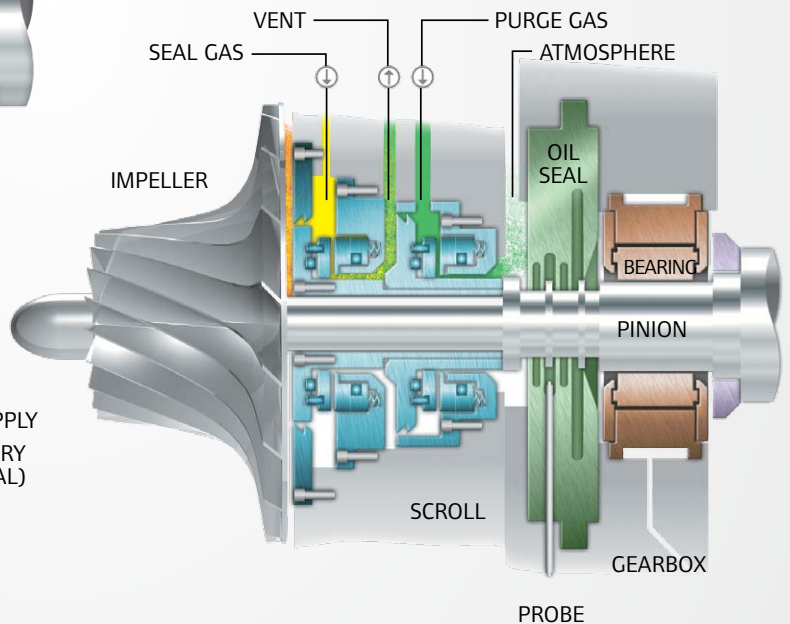

Tandem dry-face seal with integral labyrinth

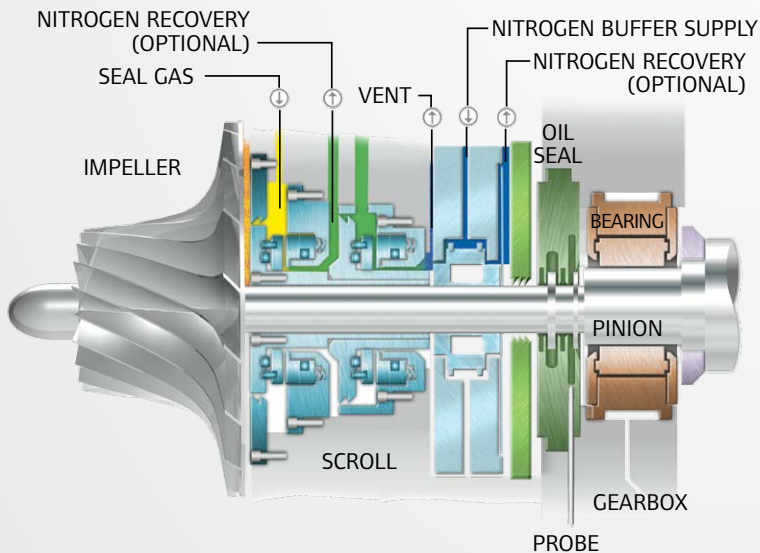

Tandem dry-face seal with carbon ring back-up

Fuel Gas Boosting

For natural gas-fired power plants, fuel gas boosters are used to raise the natural gas pipeline pressure to the inlet pressure required by the gas turbine. The fuel gas booster maintains a consistent supply of fuel gas at a specified discharge pressure to the turbine generators.

Ingersoll Rand's centrifugal compression technology provides efficient, reliable fuel gas boosting and is capable of operating with most makes and models of natural gas-fired turbines.



The three-stage MSG-3 compressor pictured above boosts the pressure of natural gas entering power generation turbines at a combined cycle power plant in Russia

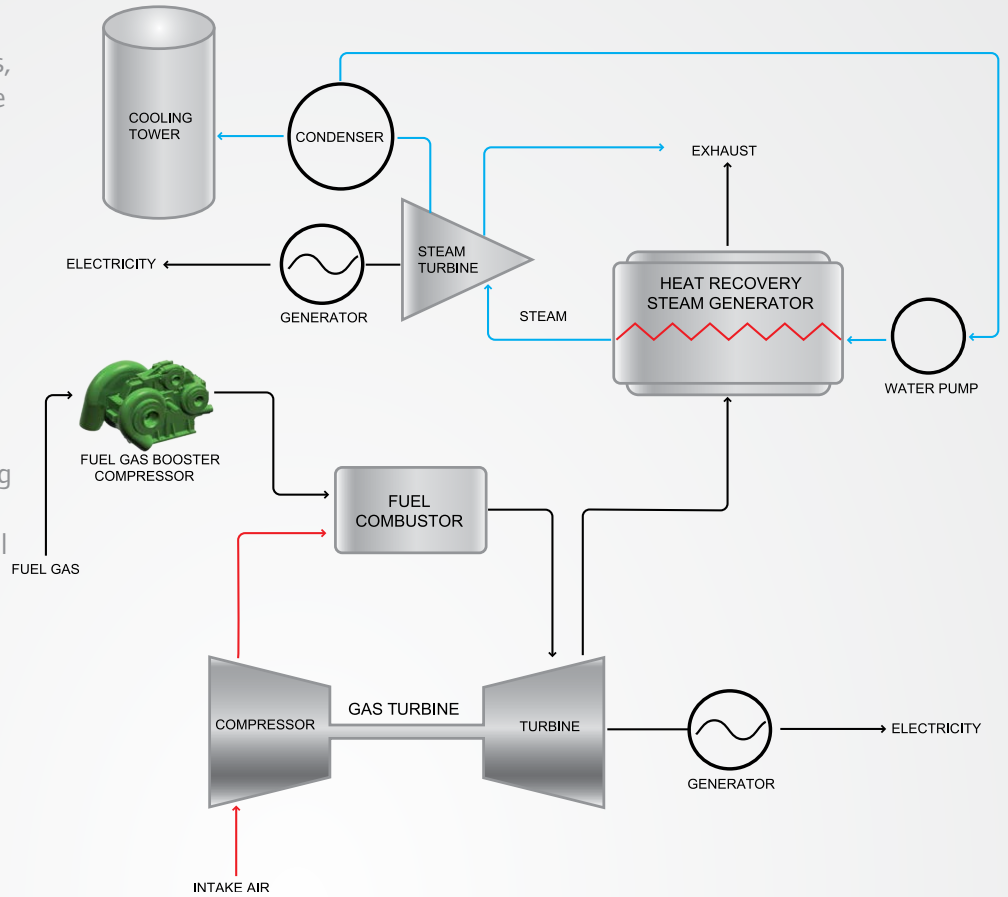

NGL Fractionation

Most natural gas extracted from the earth contains various hydrocarbon compounds, such as methane (CH_4), ethane (C_2H_6), propane (C_3H_8), and butane (C_4H_{10}). When brought to the surface and processed into purified, finished by-products, all of these are collectively referred to as NGL (Natural Gas Liquids). Fractionation is the process of separating these hydrocarbon compounds from the natural gas stream to be sold as commodities (propane, butane, etc.).

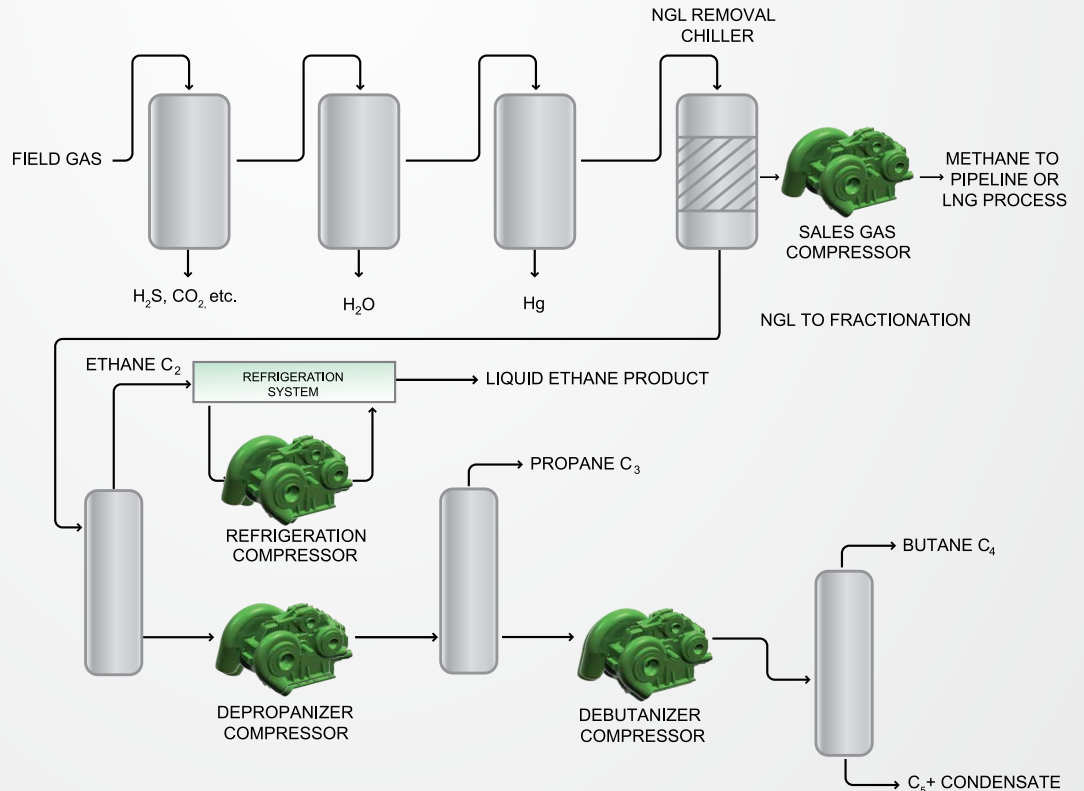

LNG Liquefaction

During the LNG process, natural gas is liquefied to approximately 1/600th of its gaseous volume, allowing for natural gas to be transported more efficiently and economically. This has revolutionized the natural gas industry, making previously unmarketable natural gas reservoirs profitable.

Ingersoll Rand has extensive experience in this process. Our custom compressors are designed to meet the varying processes and parameters involved in natural gas liquefaction.

Feed Gas Compressor

Compresses natural gas received at the plant to the required pressure for the condensate removal process

Flash Gas Compressor

Pressurizes the vapor produced during the condensate removal process

Off Gas Compressor

Compresses the natural gas to the required flow and pressure parameters needed for acid gas removal, mercury removal, and dehydration

Regeneration Gas Compressor

Restores the molecular sieve beds

Refrigeration Gas Compressor

Feeds the main cryogenic exchanger with required refrigerant (C₃, MR, N₂)

CO₂ Injection Compressor

Injects carbon dioxide into storage well

Turboexpanders

Cool the gas stream for separating out heavier hydrocarbon compounds.

Lean Gas Compressor

Raises the lean natural gas pressure to a level suitable for the main cryogenic exchanger.

End Flash Gas Compressor

Pressurizes the vapor produced during the refrigeration process

Boil-Off Gas Compressor

Re-pressurizes boil-off gas for re-liquefaction, or use in this gaseous state

N₂ Booser Compressor

Adjusts the calorific value of sales gas

Fuel Gas Compressor

Elevates the pressure of the gas stream to the inlet pressure required by the turbine

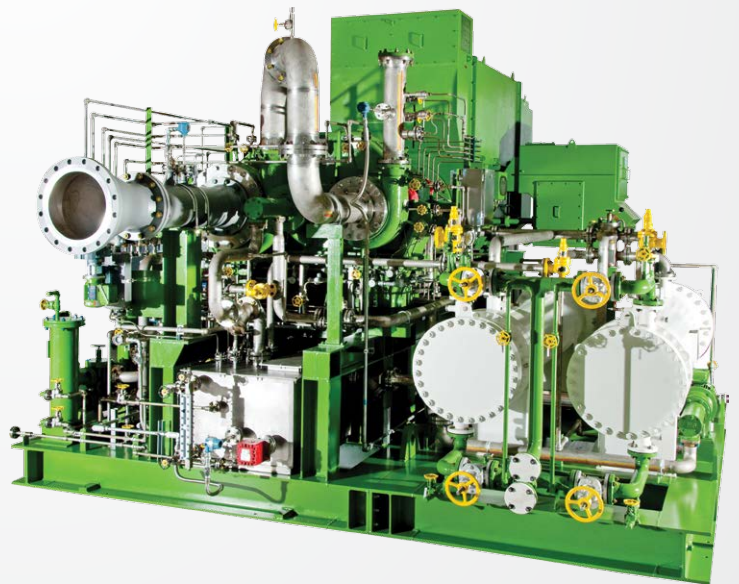
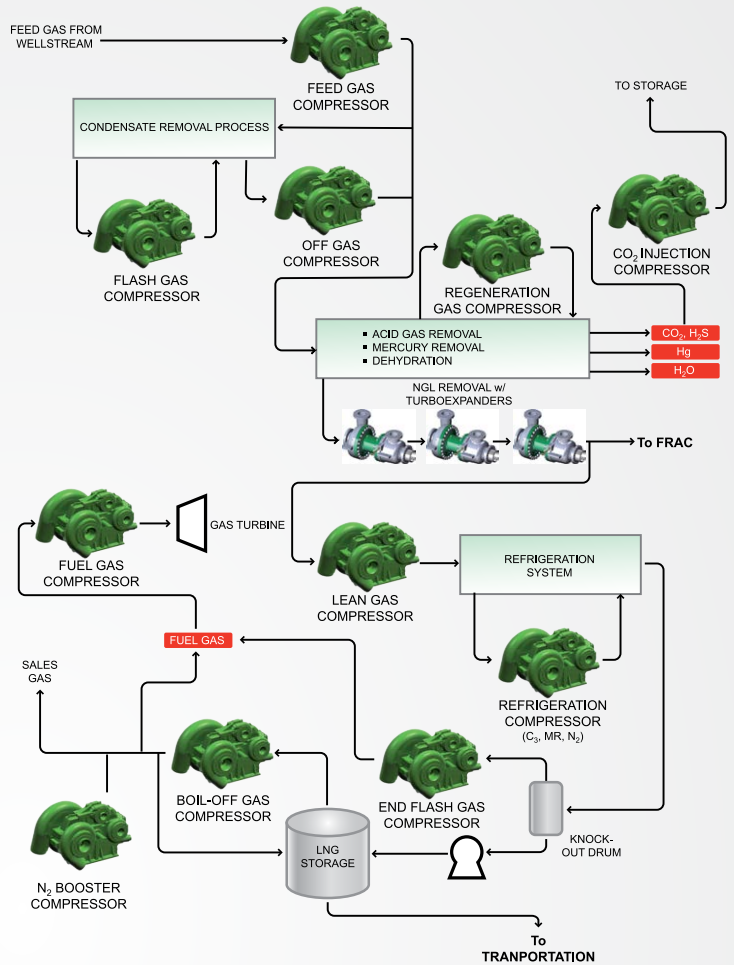

The two-stage MSG-7 compressor pictured above handles propane in a refrigeration loop at a refinery in South Korea.

Fertilizer

Ammonia

The revolutionary process of synthesizing ammonia (NH_3) that was developed by German chemists in 1909 is still used today. The Haber-Bosch process uses atmospheric nitrogen along with hydrogen to synthesize ammonia.

Today, natural gas is often used as feedstock for obtaining hydrogen for the process. Ingersoll Rand has designed solutions for the many compressor applications required by the Haber-Bosch process.

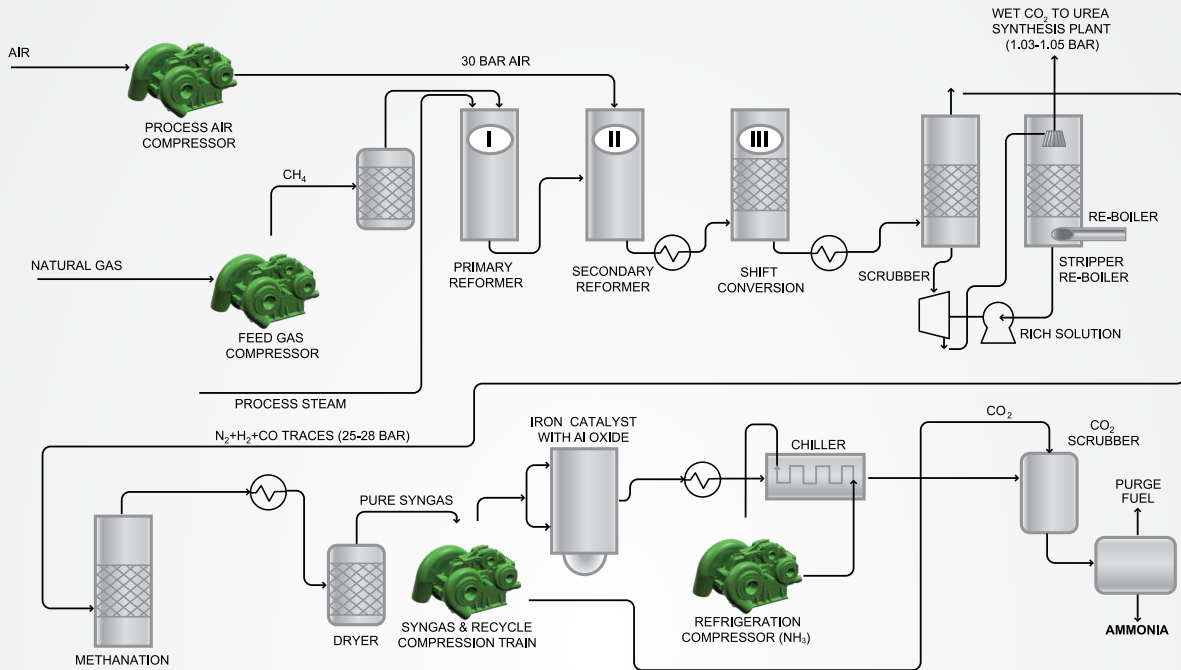

Urea

Ingersoll Rand's design expertise for fertilizer solutions extends downstream to the urea synthesis process. Urea is produced from synthetic ammonia and carbon dioxide (CO_2). Urea production plants are frequently located near ammonia production plants. The production of ammonia creates large quantities of carbon dioxide by-product that is used as a feedstock, along with some of the synthesized ammonia, for producing urea.

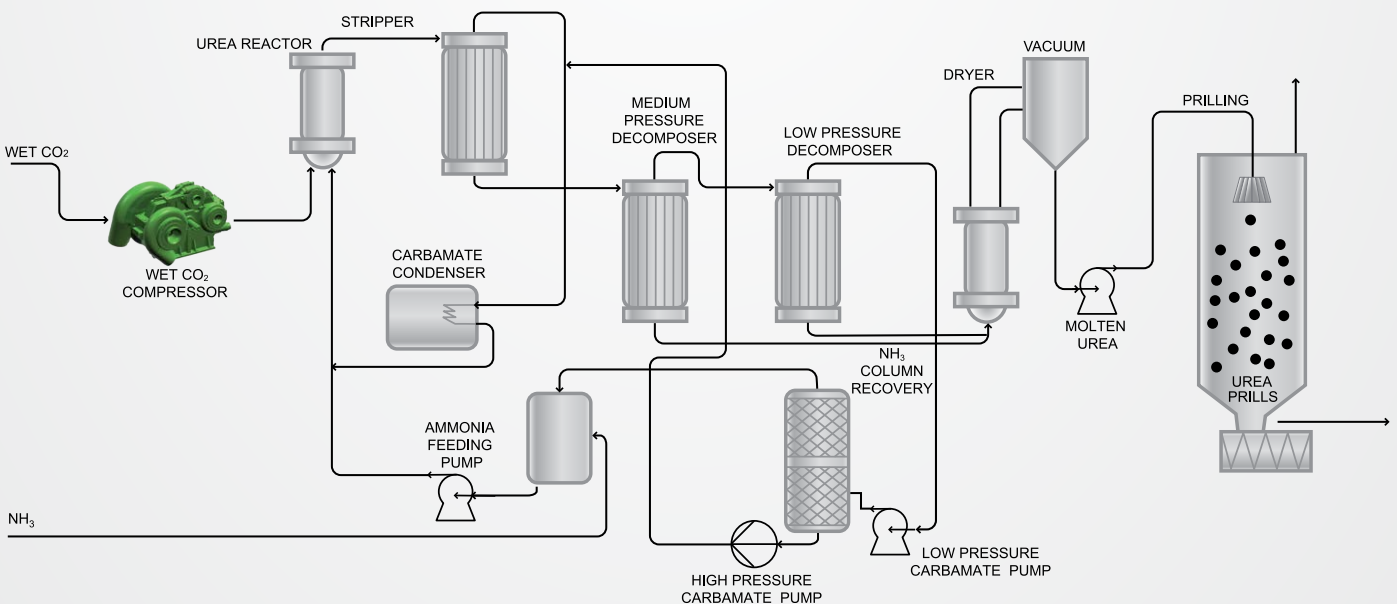

Carbon Monoxide Processing

HyCO

Through various reforming or oxidation processes (depending on feedstock) fossil fuels can be converted to hydrogen, carbon monoxide or a mixture of the two gases. The process generates carbon dioxide as a by-product which can be captured for storage, sequestration, and recycling back into the reforming process. Our extensive gas compressor design and manufacturing knowhow allow us to engineer the right gas compressor for your HyCO process.

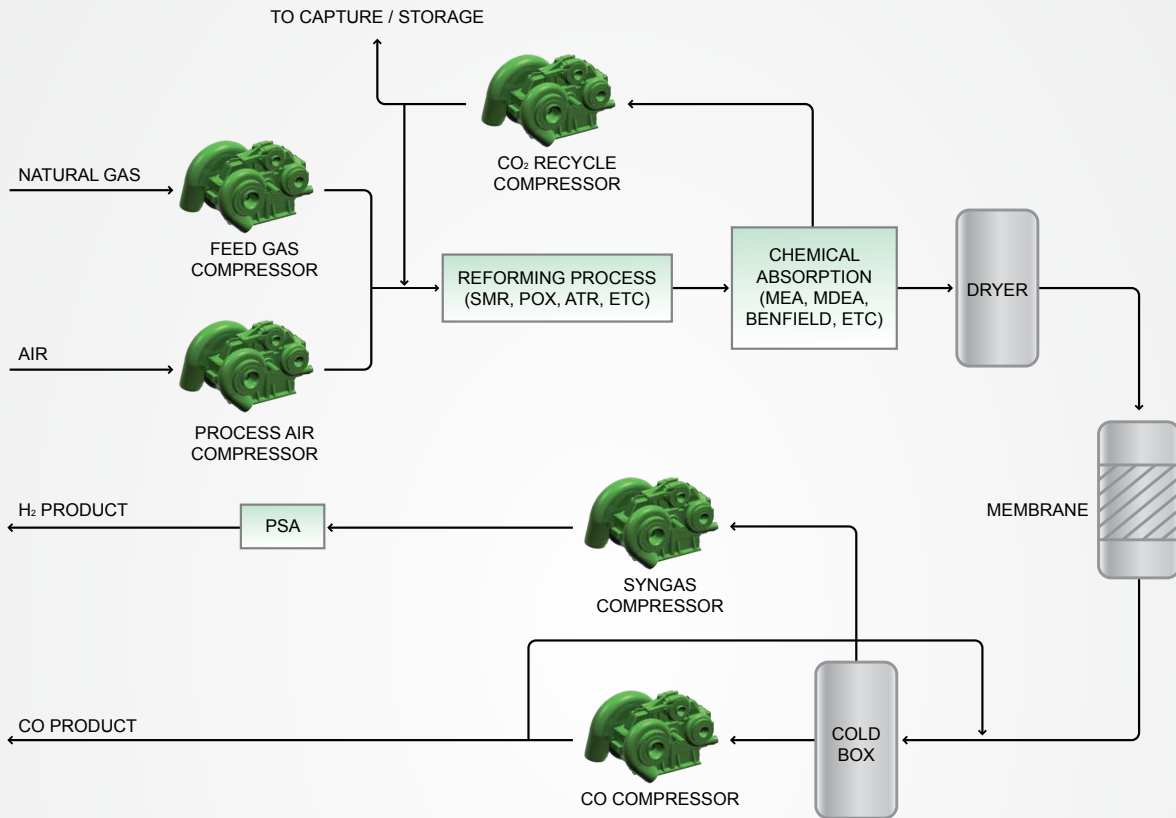

Biological Conversion

Carbon monoxide-rich waste gas from industrial processes, like steel manufacturing, can be converted into biofuels utilizing gas-fermenting microbes that feed on the waste gas. Ingersoll Rand is closely partnering with various leaders in this industry to convert CO waste gas into viable energy products.

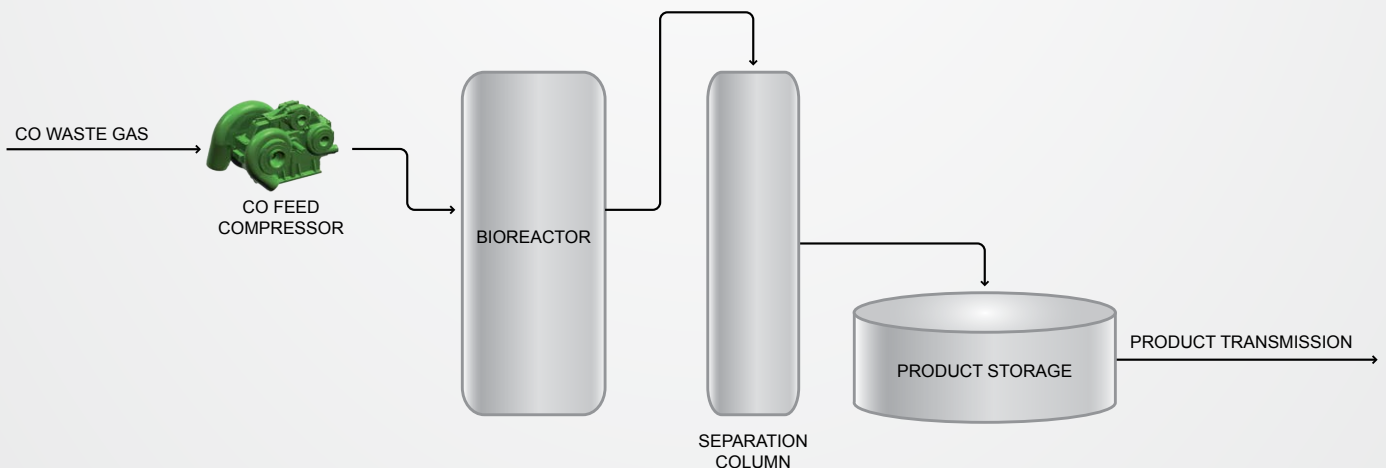

Aftermarket Services and Support

How else can we prove our commitment to your total satisfaction? By providing the industry's most comprehensive resource for top-notch aftermarket products, engineering solutions and field service. If you ever have a question or problem, Ingersoll Rand's extensive network of highly skilled technicians and authorized representatives is at your service.





Installation and Startup

- Machine commissioning services
- Diagnostic and troubleshooting services
- Vibration analysis and trending
- Extended warranty and preventative maintenance programs

Elite Technical Support

- Installation and operation support
- Our goal is to help keep your unit running

Technical Training

- Comprehensive training seminars for you and your personnel
- Instructions on a variety of topics, including courses with hands-on training
- Courses can be tailored to your needs at one of our global training centers

Repair Expertise

- State-of-the-art equipment for turnkey repairs
- Complete documentation packages
- Strategic repair center locations to serve a broad customer base, including Buffalo, NY, US; Houston, TX, US; Milan, Italy; Ahmedabad, India; Shanghai, China

Exceptional Parts

- Genuine parts produced in the same facility for more than 60 years
- Extensive inventory in strategic locations around the world, backed by our written warranty
- Cross-checked against engineering records to ensure correctness





Ingersoll Rand (NYSE:IR) advances the quality of life by creating comfortable, sustainable and efficient environments. Our people and our family of brands—including Club Car®, Ingersoll Rand®, Thermo King® and Trane®—work together to enhance the quality and comfort of air in homes and buildings; transport and protect food and perishables; and increase industrial productivity and efficiency. We are a \$13 billion global business committed to a world of sustainable progress and enduring results.



IngersollRandProducts.com

Distributed by:

Ingersoll Rand, IR, the IR logo, MSG, MSG TURBO-AIR and MAESTRO are trademarks of Ingersoll Rand, its subsidiaries and/or affiliates. All other trademarks are the property of their respective owners.

Nothing contained on these pages is intended to extend any warranty or representation, expressed or implied, regarding the product described herein. Any such warranties or other terms and conditions of sale of products shall be in accordance with Ingersoll Rand's standard terms and conditions of sale for such products, which are available upon request.

Product improvement is a continuing goal at Ingersoll Rand. Any designs, diagrams, pictures, photographs and specifications contained within this document are for representative purposes only and may include optional scope and/or functionality and are subject to change without notice or obligation.